

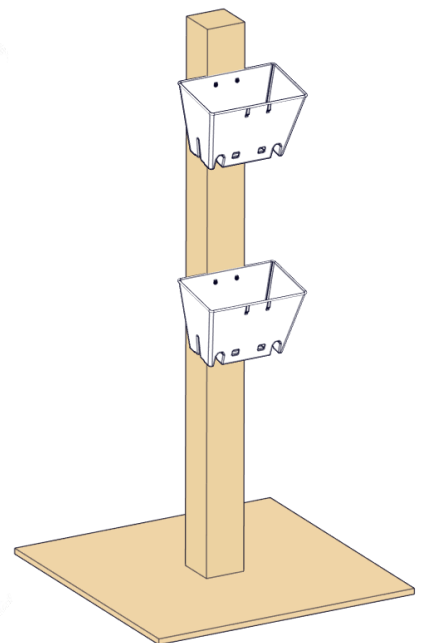

PRESENTED BY  **RTX**

2024-2025 *FIRST*[®] Tech Challenge Do-It-Yourself Field Guide

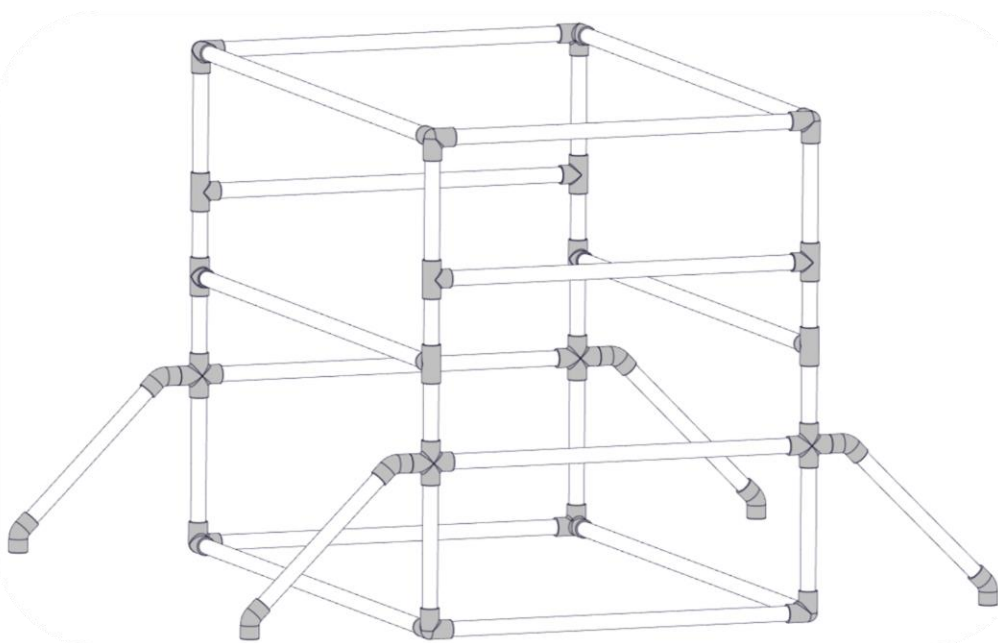

Revision #	Date	Author	Purpose
0	9/7/2024	E. Scime	Release

Table of Contents

Page #	Section
4	Recommended Tools List
5	Submersible Parts List
6	Basket Structure Parts List
7	Submersible Assembly
15	Basket Structure Assembly
23	Basket Structure Drill Guide







Recommended Tools List

Component	Part #	Quantity	Photo
Tape Measure	am-4986	1	
7/64" Drill Bit	am-4523	1	
Driver Bit Matching Your Woodscrews	Home Depot 1006021131	1	
PVC Cutter	Home Depot 1003002231	1	
Drill	Home Depot 1006703281	1	
Wood Cutting Saw	Home Depot 1004493359	1	
Safety Gloves	Home Depot 1001088660	1	
Permanent Marker	Home Depot 451153	1	
(Optional) Metal Cutting Saw	Home Depot 1000032947	1	
Mallet	Home Depot 1004723572	1	







Submersible Parts List

Component	Part #	QTY	Photo
3/4" Nominal PVC Pipe (1.05" OD, Schedule 40)	Home Depot 193712	~60ft	
PVC Elbow with Side Outlet	Home Depot 1002146031	8	
PVC Tee Fitting	Home Depot 187917	8	
PVC 45 Degree Fitting	Home Depot 188026	8	
PVC Cross Fitting	Home Depot 232505	4	
(Optional) 1/2", 4' or longer Nominal Electrical Conduit	Home Depot 242955	4	



Basket Structure Parts List

Component	Part #	QTY	Photo
Empty 2qt Ice Cream Container (or similar container measuring roughly 9" by 5.75" by 6" deep)	N/A	2	
(Optional) Basket	AndyMark am-3015	2	
4x4 Dimensional Lumber, 44" in length or longer.	Home Depot 256276	1	
2' x 2' x 1/2" Plywood	Home Depot 1000337169	1	
Wood Screws, 1"-2" Acceptable	Home Depot 832438	8	



SUBMERSIBLE ASSEMBLY

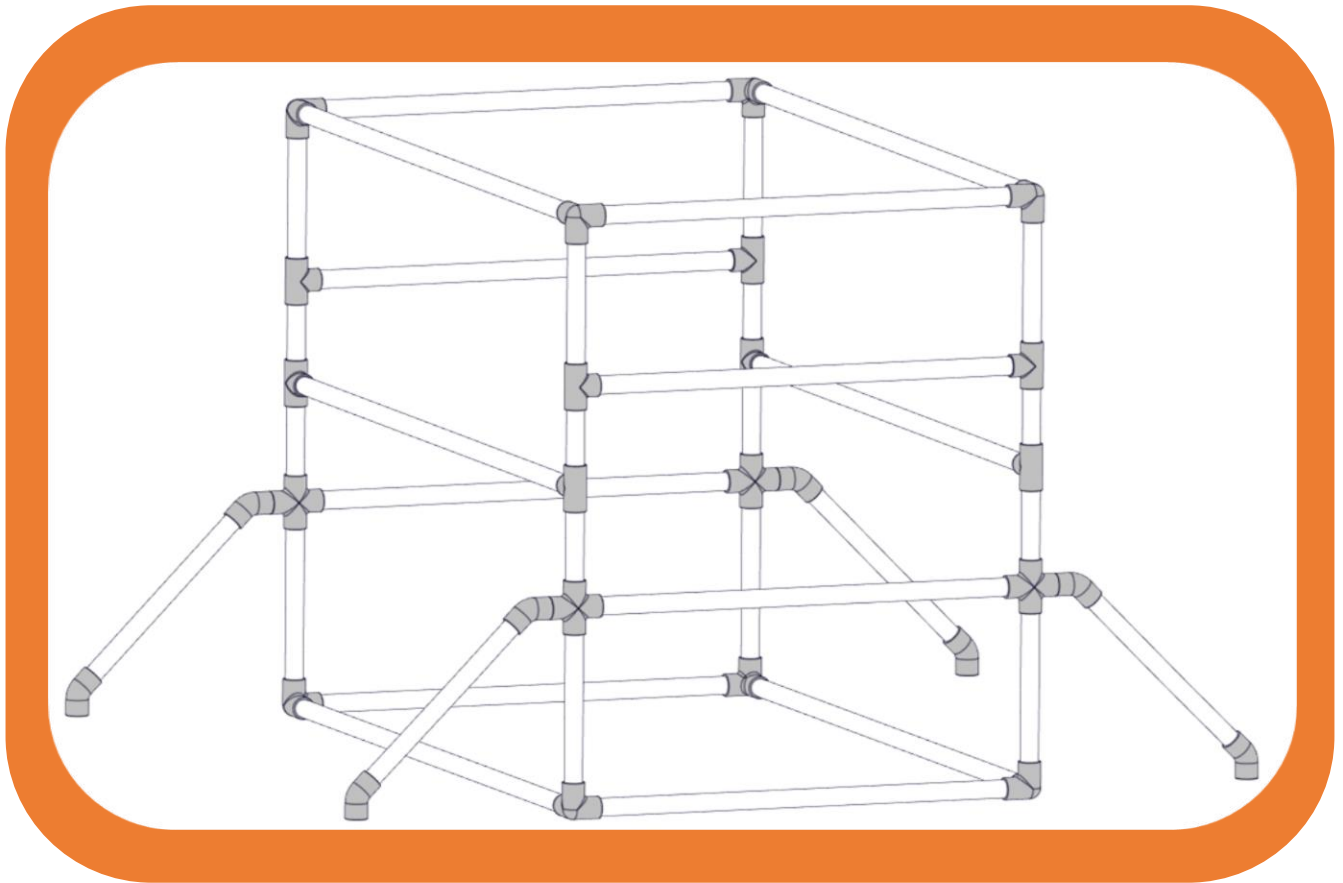

Submersible Assembly

Step 1

Cut the various lengths of PVC pipe you will need for assembly using a saw or a PVC cutter.

Keep in mind that some manufacturers' PVC fittings allow for pipe inserts of different lengths, which may require adjustments to these lengths.

Part ID	QTY	Length
A	6	45-3/8"
B	8	27-3/8"
C	4	15"
D	4	10-7/8"
E	4	8-7/8"
F	4	5-7/8"
G	4	4-7/8"
H	4	2"

Step 2

Assemble the base of the Submersible with [2] part As, [2] part Bs, and [4] Elbows with Side Outlets.

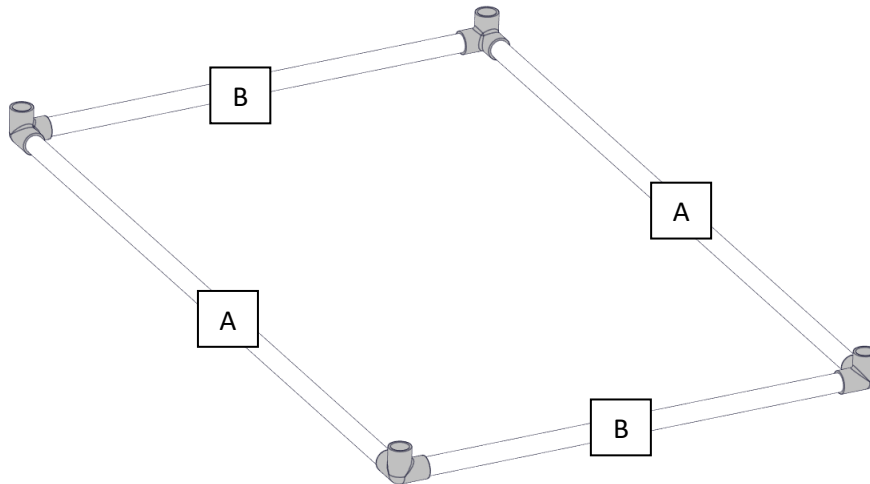

Step 3

Insert [4] part Ds into the open slots on the installed fittings.

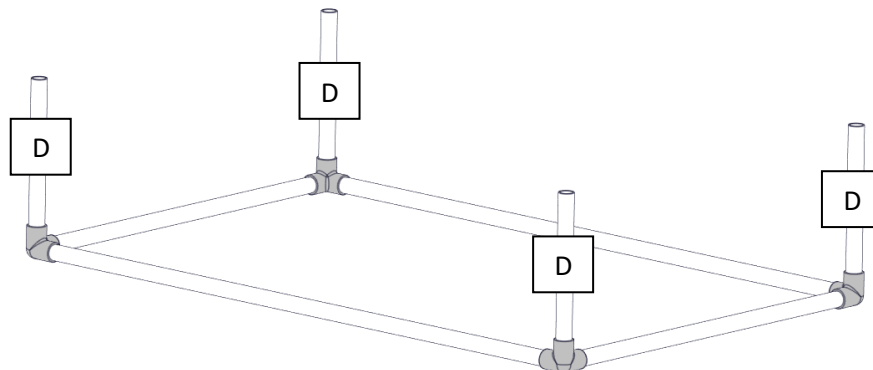

Step 4

Create [2] assemblies, each with [1] part B and [1] cross fitting at either end. Attach them to the larger assembly at the locations where the part Ds were placed in Step 3, as shown. Ensure the top of each Part B is 13" from the floor.

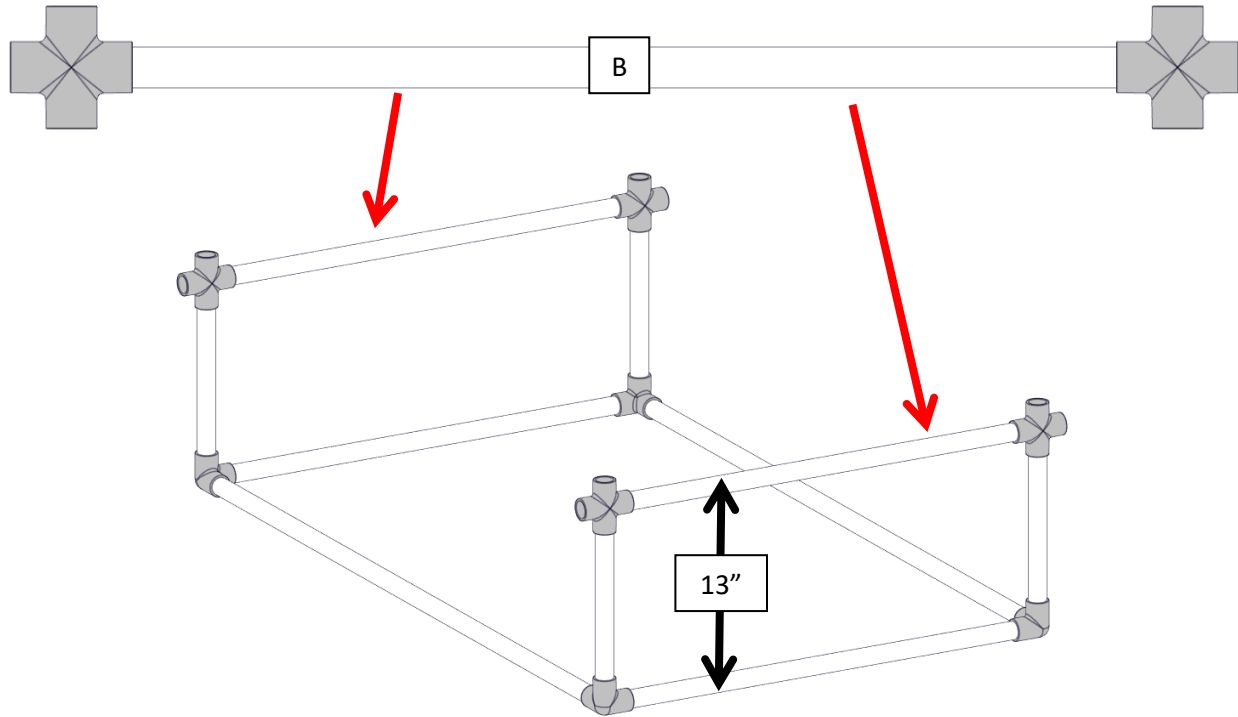

Step 5

In the open slots on the cross fittings facing away from the frame, insert [4] part Hs, as shown.

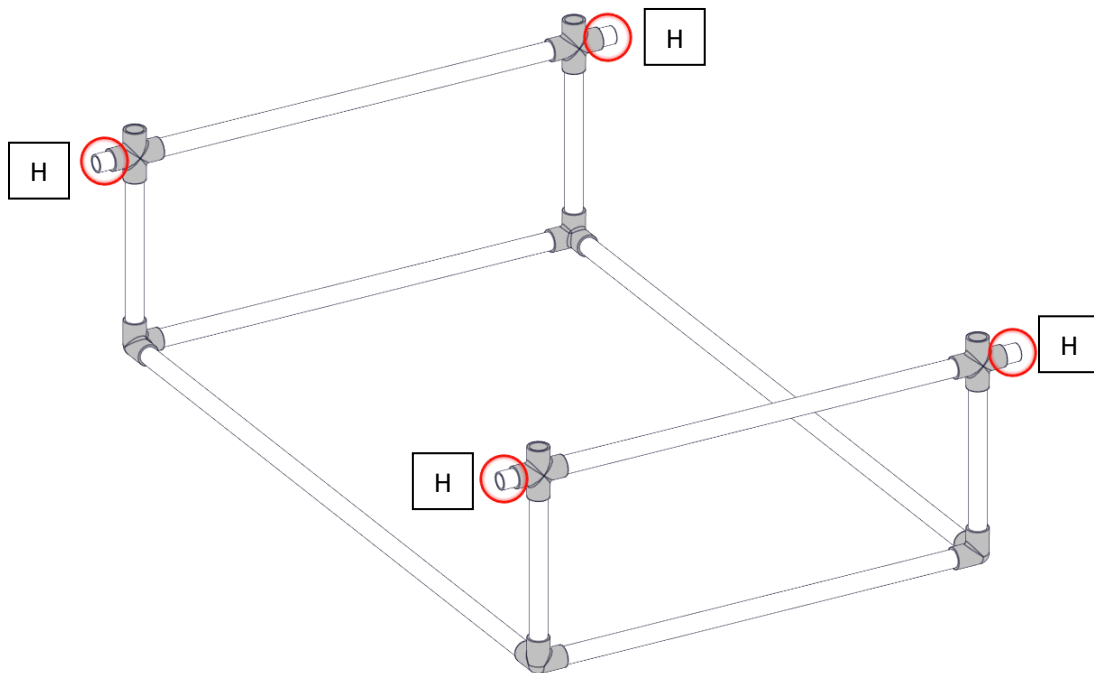

Step 6

Create [4] outrigger assemblies, each with [1] part C and [1] 45 degree fitting at either end. Ensure the fittings are rotated such that they occupy the same plane, as shown. Attach them to the larger assembly at the locations where part Hs were placed in Step 5. These should touch the ground.

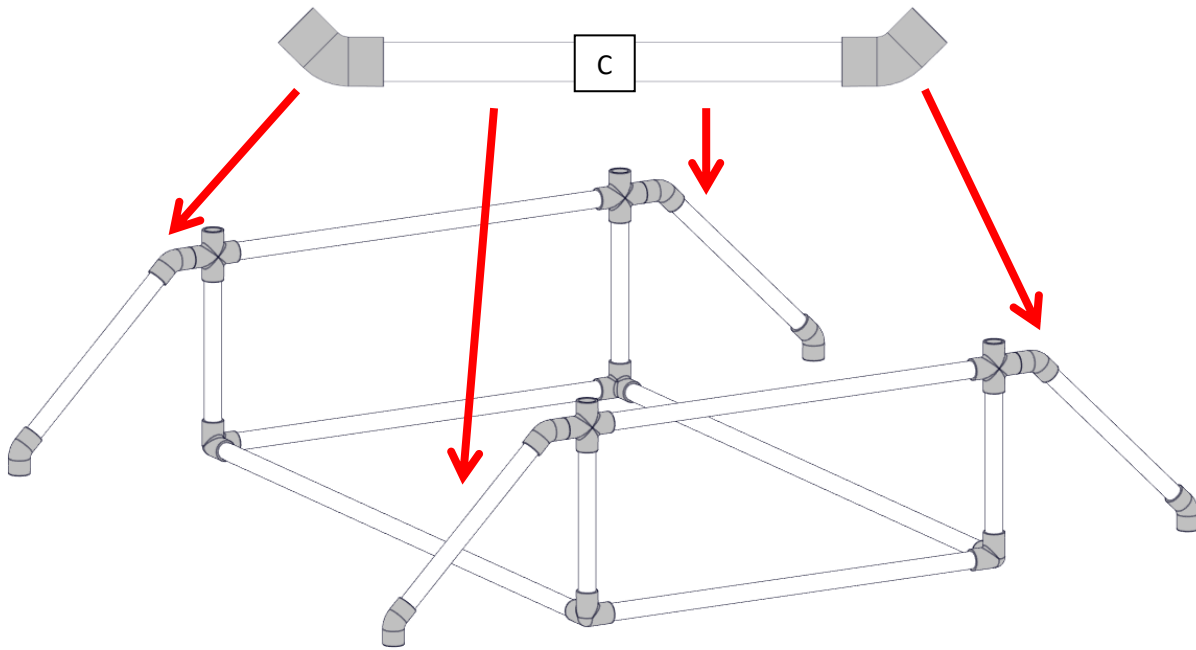

Step 7

Insert [4] part Fs into the open slots on the cross fittings, as shown.

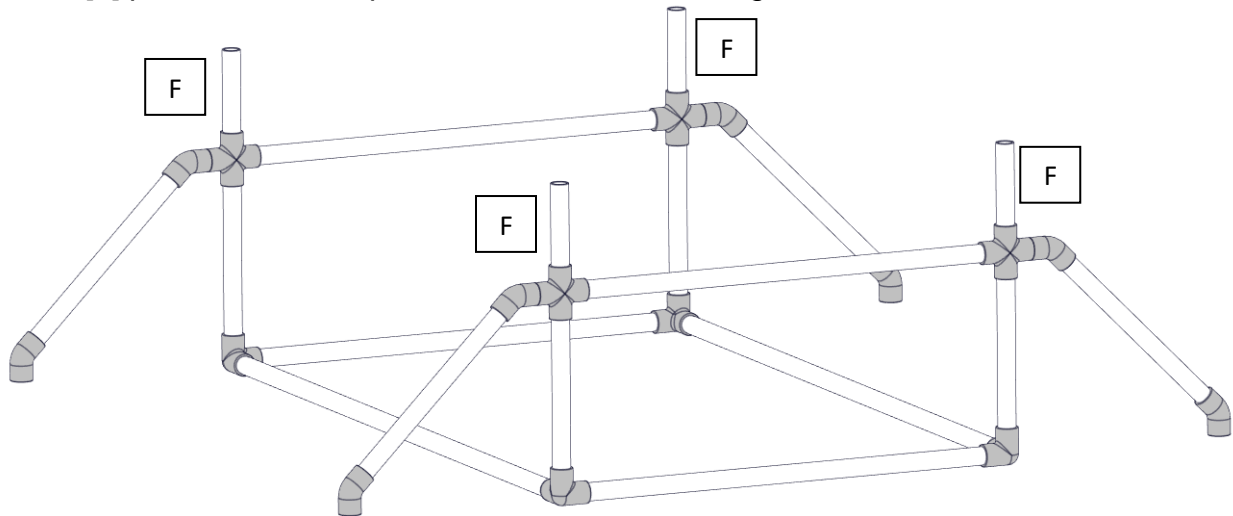

Step 8

Tap [4] tee fittings onto [2] part As. Place the assemblies on top of the part Fs placed in Step 7. Ensure the top of each Part A is 20" from the floor.

(Optional) To increase the stiffness of this climbing rung for use by heavier robots, slide an electrical conduit cut to the same length as part A inside part A before connecting the tee fittings.

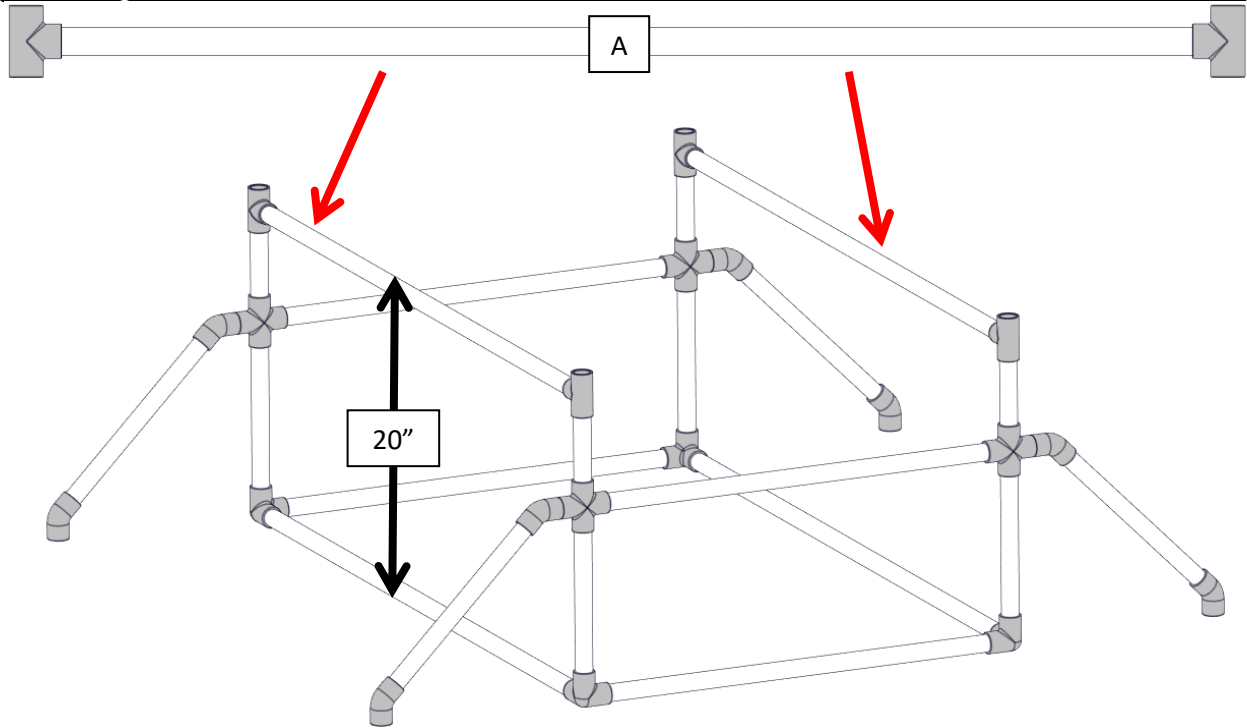

Step 9

Insert [4] part Gs into the open slots on the tee fittings, as shown.

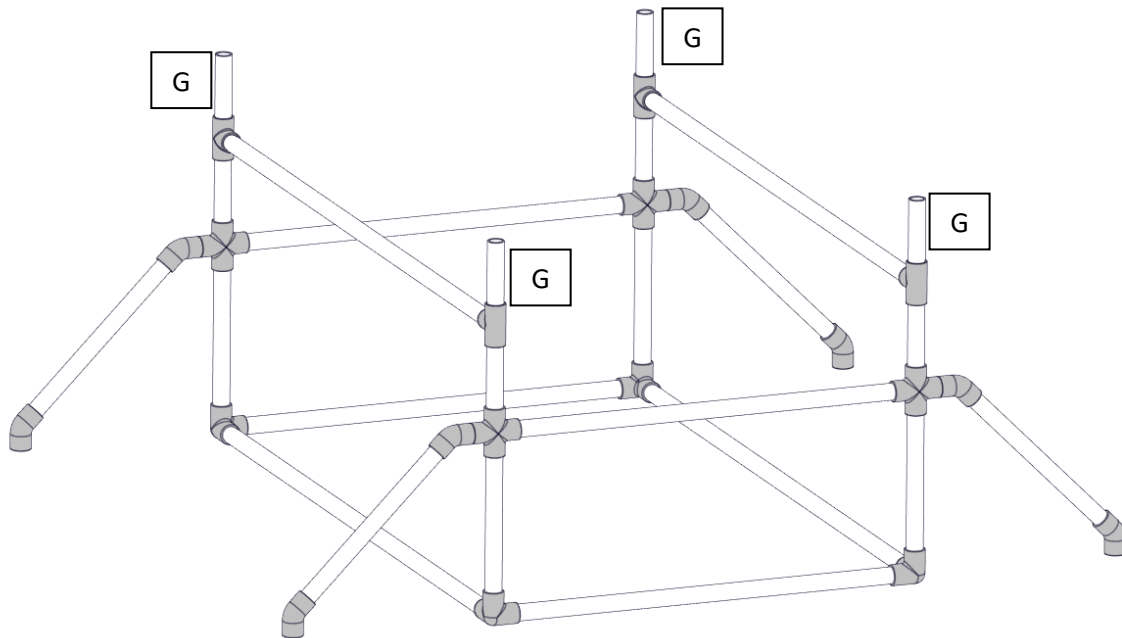

Step 10

Tap [4] tee fittings onto [2] part Bs. Place the assemblies on top of the part Gs placed in Step 9. Ensure the top of each Part B is 26" from the floor.

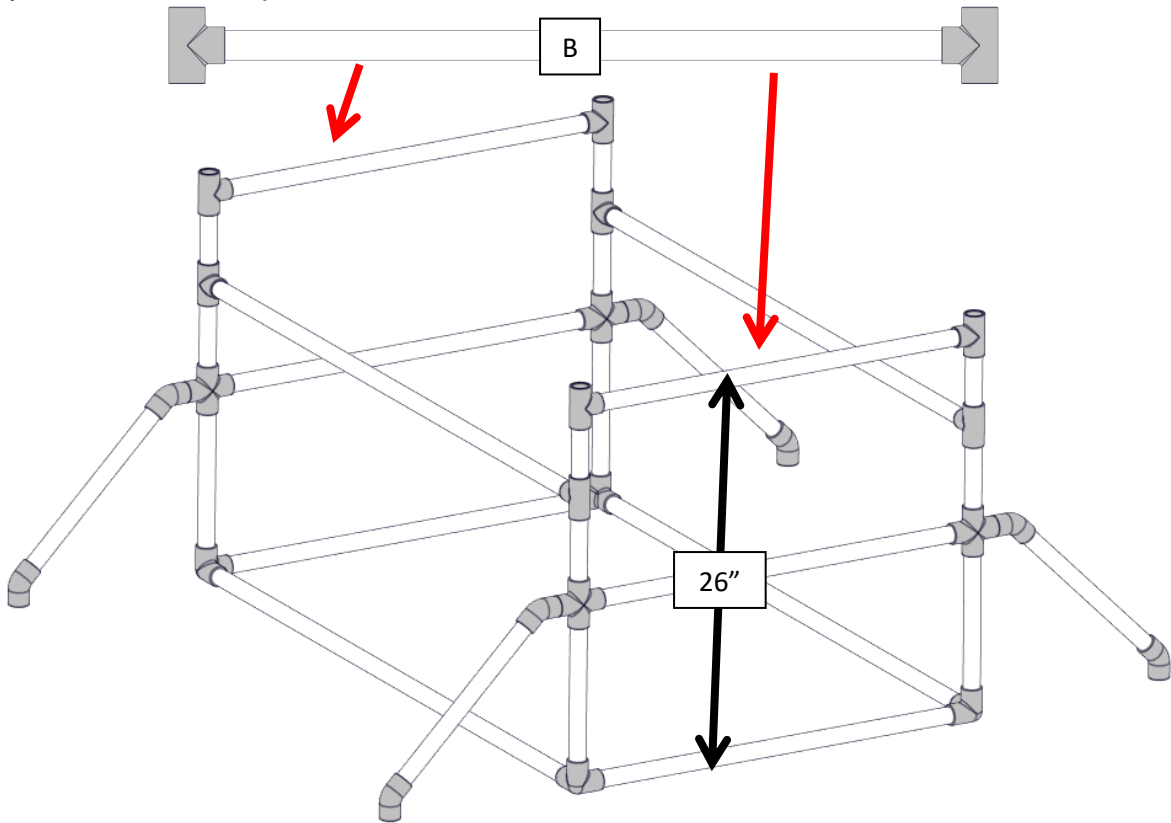

Step 11

Insert [4] part Es into the open slots on the tee fittings, as shown.

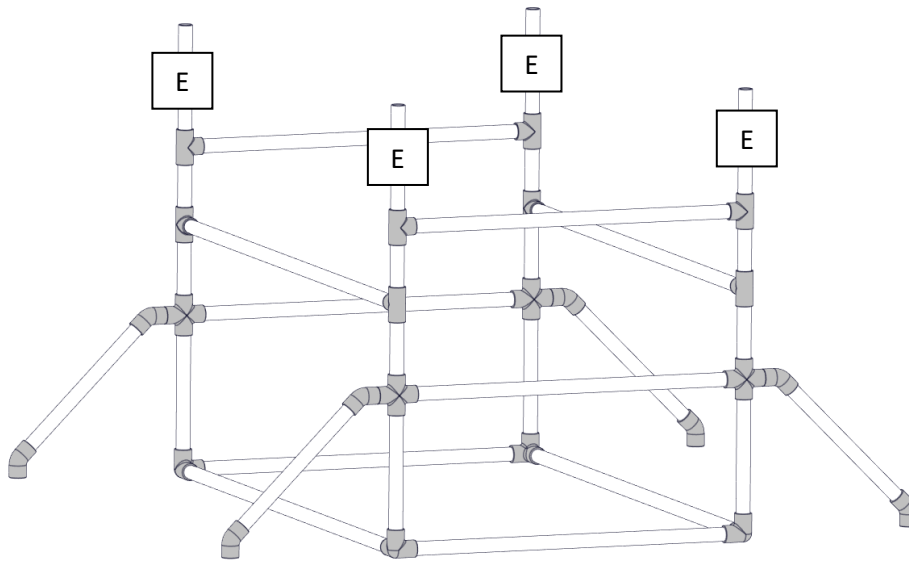

Step 12

Create a frame using [2] part As, [2] Part Bs, and [4] Elbows with Side Outlets as shown. Attach it to each of the Part Es placed in Step 11. The Submersible is now complete. Ensure the top of the assembly is 36" from the floor.

(Optional) To increase the stiffness of this climbing rung for use by heavier robots, slide an electrical conduit cut to the same length as part A inside part A before connecting the elbows with side outlets.

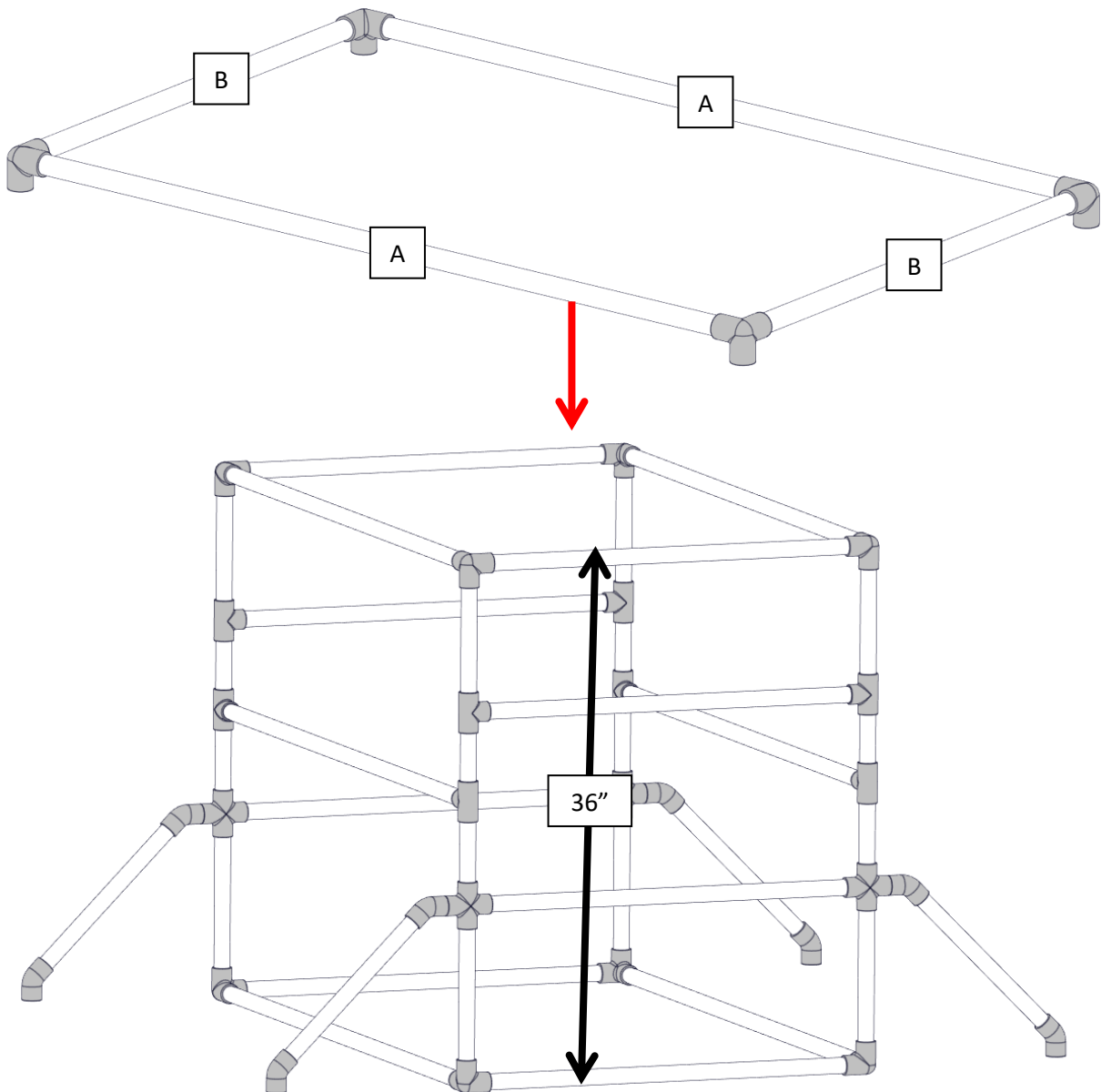

Step 13

Verify the critical features are at the correct heights by comparing to the diagram below. Each height is measured from the floor to the top of the corresponding horizontal PVC pipe.

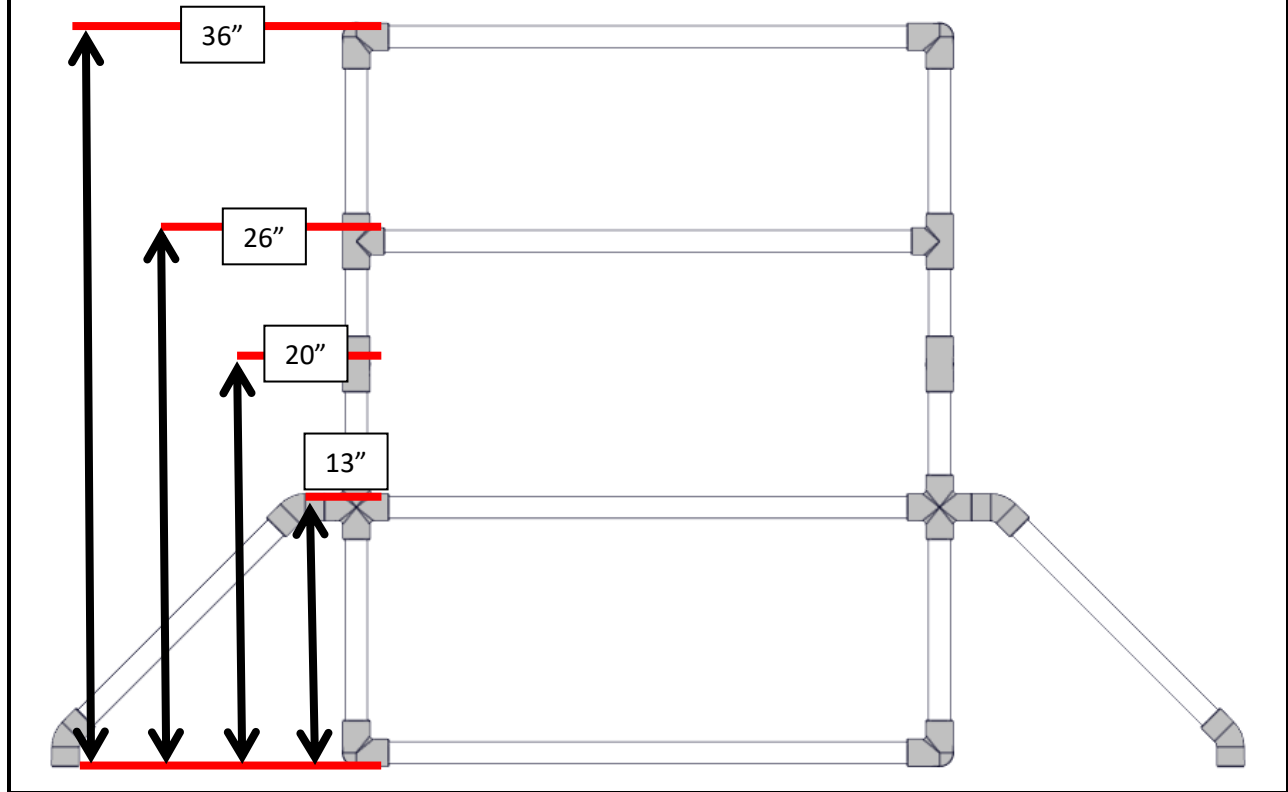

BASKET STRUCTURE ASSEMBLY

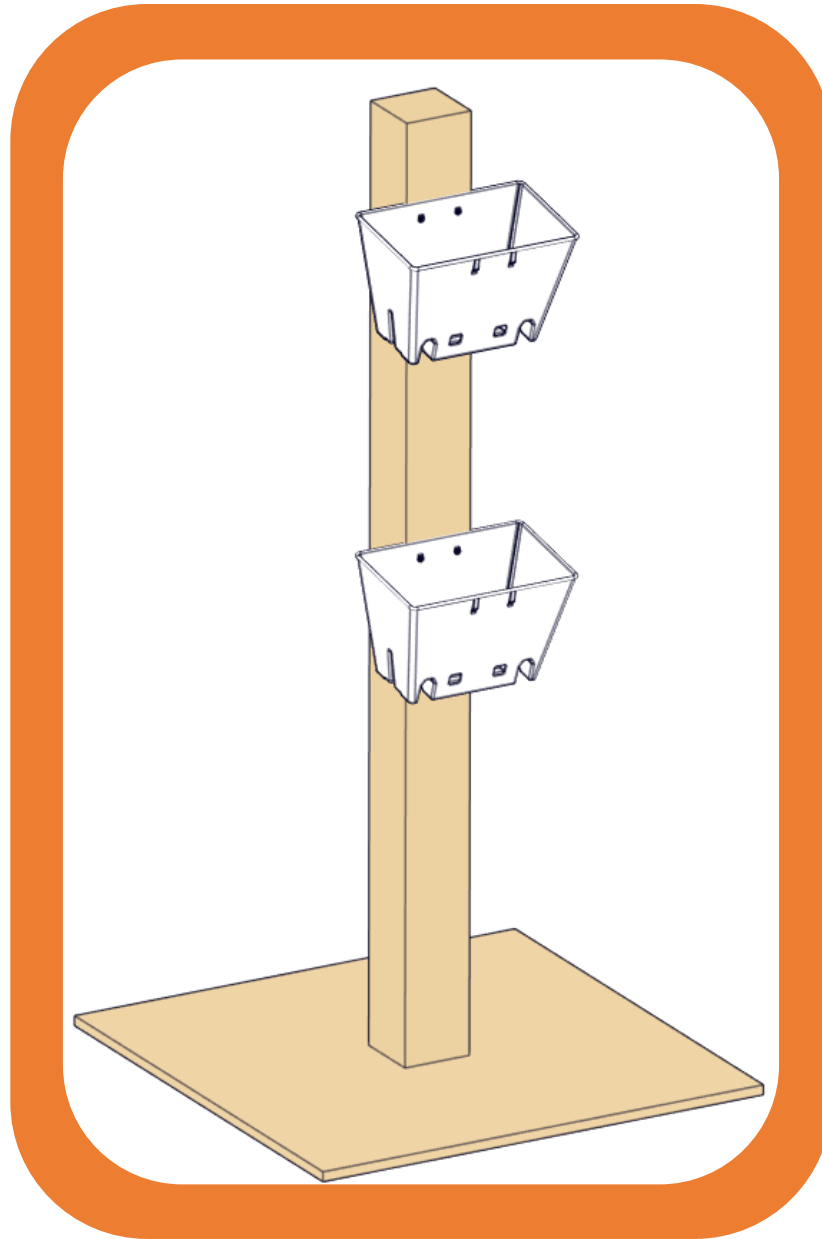

BASKET Structure Assembly

Step 1

Cut the 4x4 to 44" in length first, to provide a more accurate overall height for the Basket Structure.

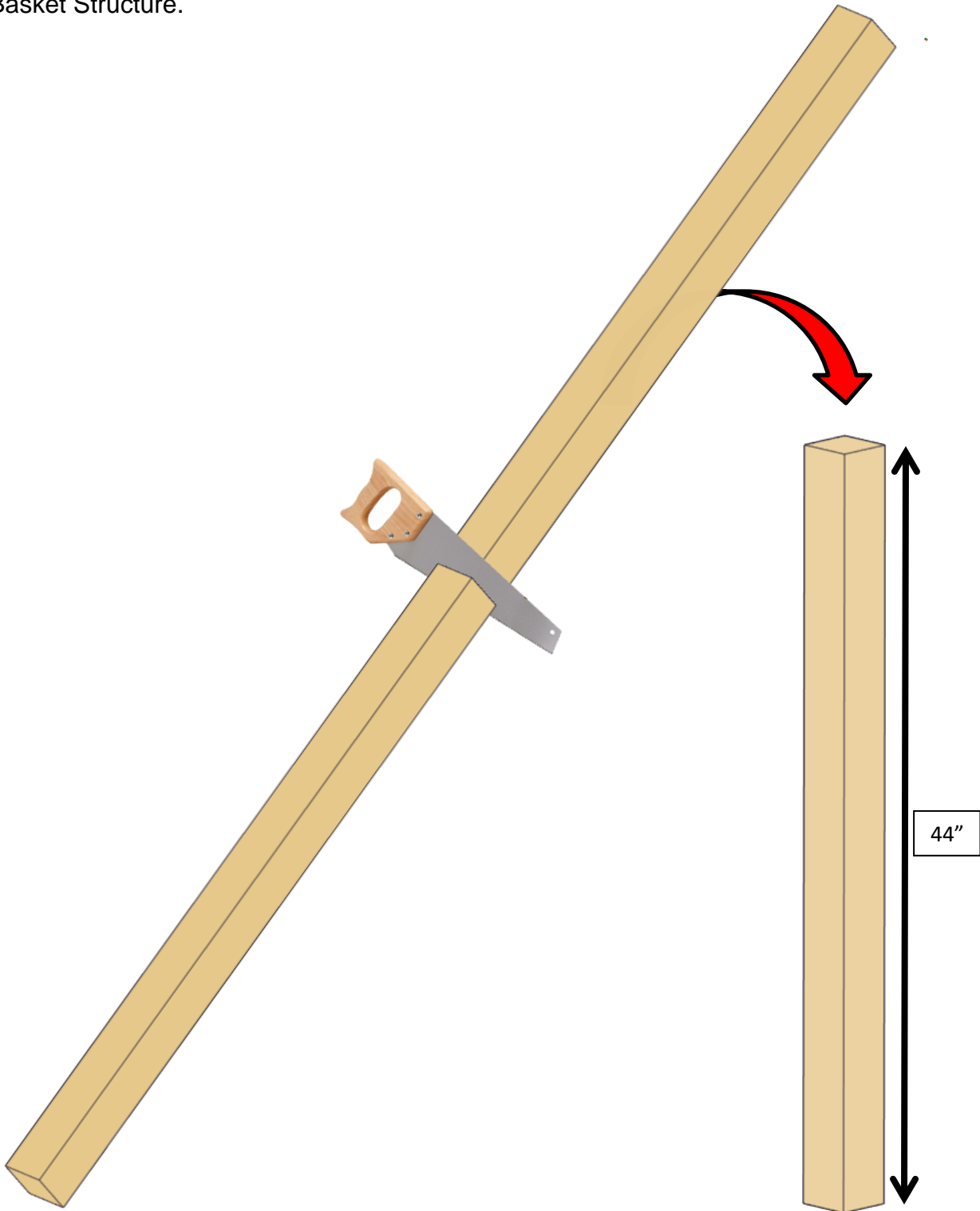

Step 2

Print out [2] drill guides from the page at the back of this guide. On the 4x4 Dimensional Lumber, attach the first drill guide to the bottom, centered. Pushpins or tape are ideal for holding it in place. Then drill the four [4] holes shown on the guide using the 7/64" drill bit. Drill about a half inch into the wood. These are "Pilot Holes" that will help guide woodscrews later.

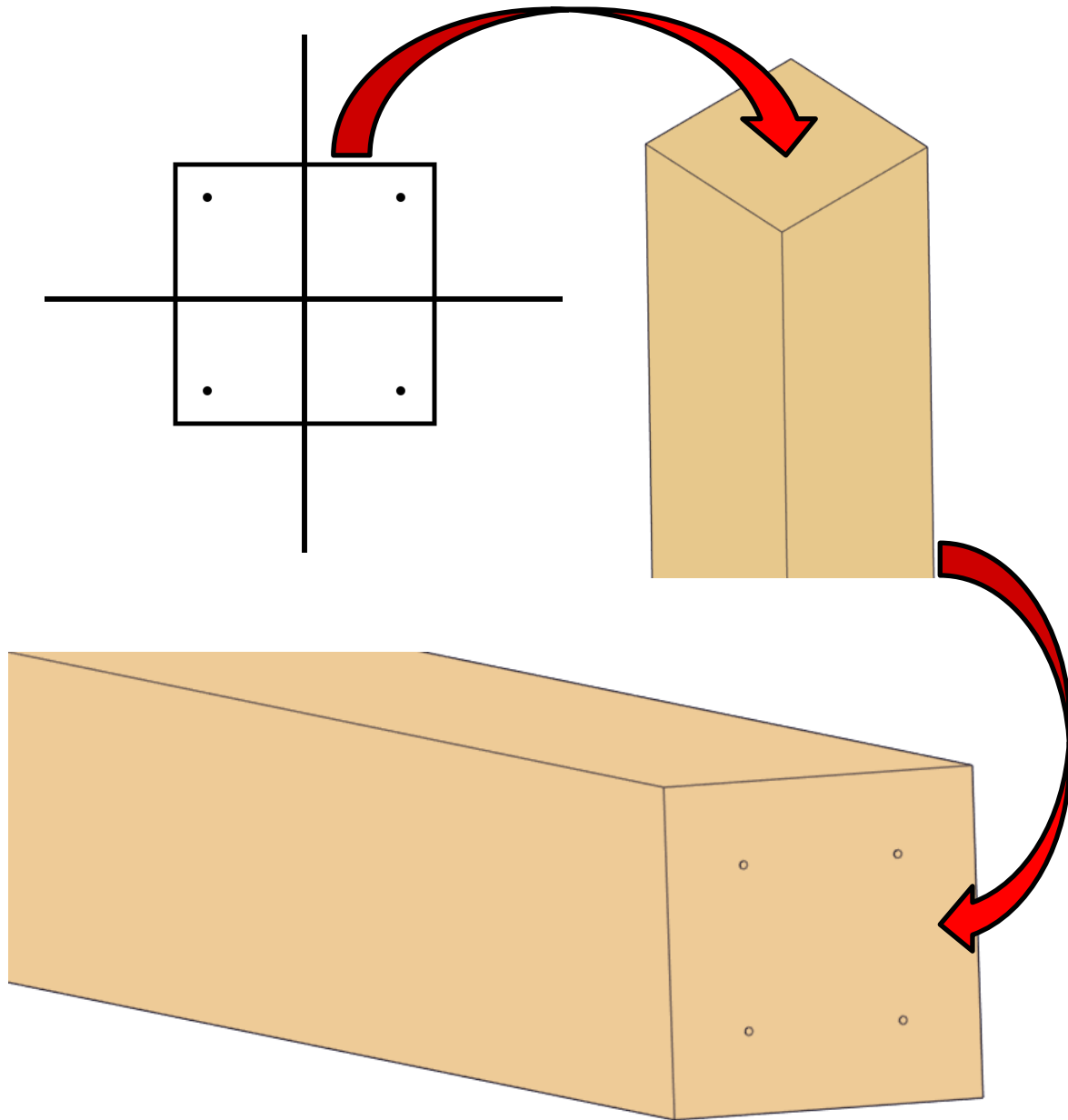

Step 3

Use the lines on the second drill guide, a sharpie or pencil, and the tape measure to center the guide on the 2ft x 2ft plywood. Pin the drill guide in place. Use the drill bit to drill out all [4] holes completely.

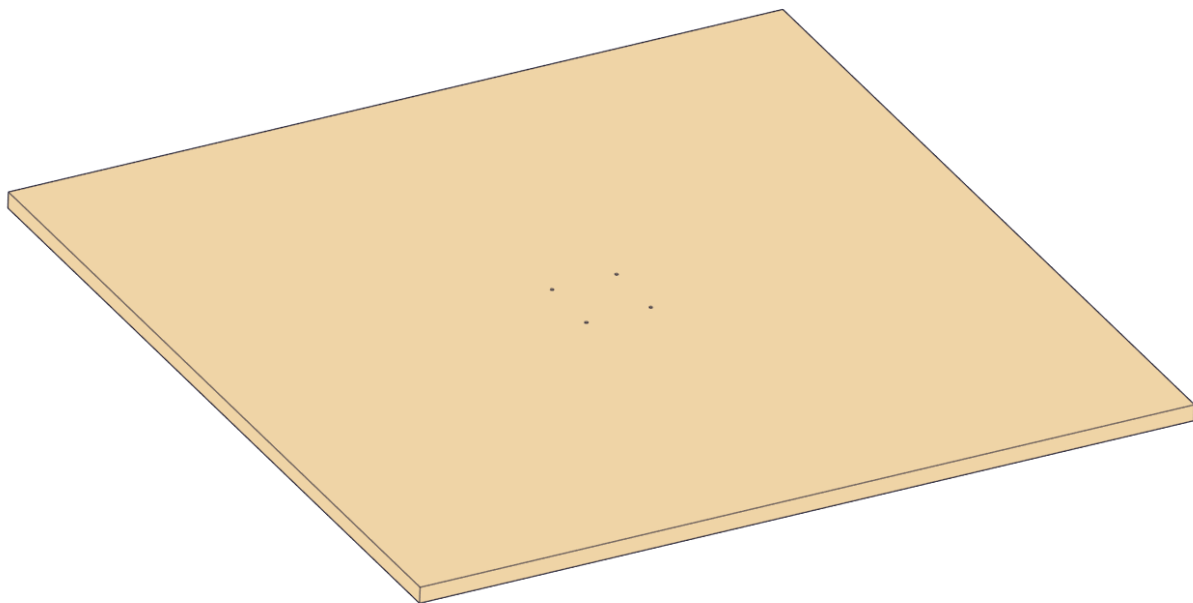
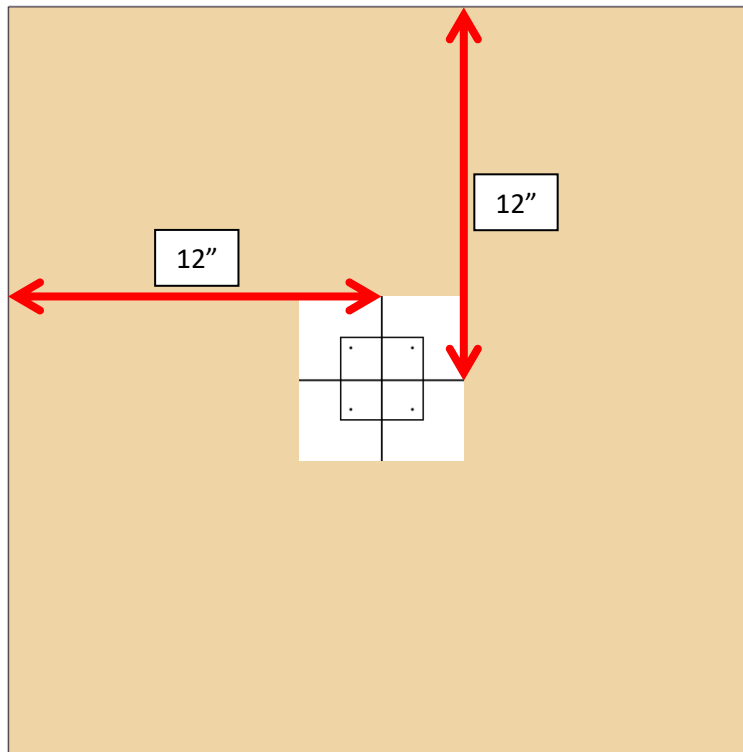

Step 4

Insert [4] woodscrews through the plywood and into the dimensional lumber using a drill. Tighten each screw to ensure a secure, flat fit between the two parts.

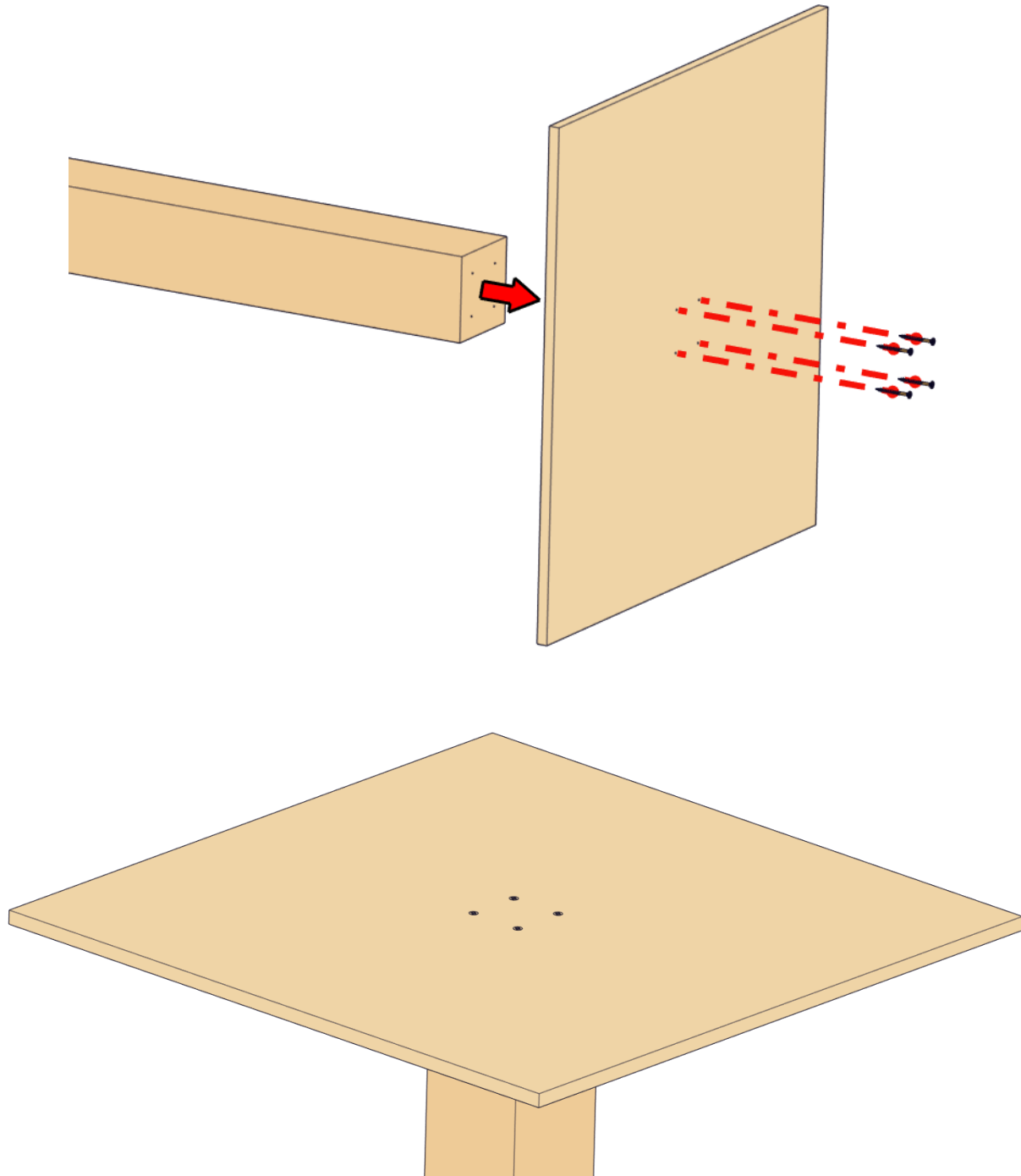

Step 5

Measure up from the top surface of the plywood $42\text{-}1/8"$. Mark this location with a permanent marker or pencil. Repeat this $25\text{-}5/8"$ up from the top surface of the plywood. Mark $3/4"$ in from either side of the 4x4 on both of these measurements as shown. Drill pilot holes at the intersections of the marks, each about $1/2"$ deep.

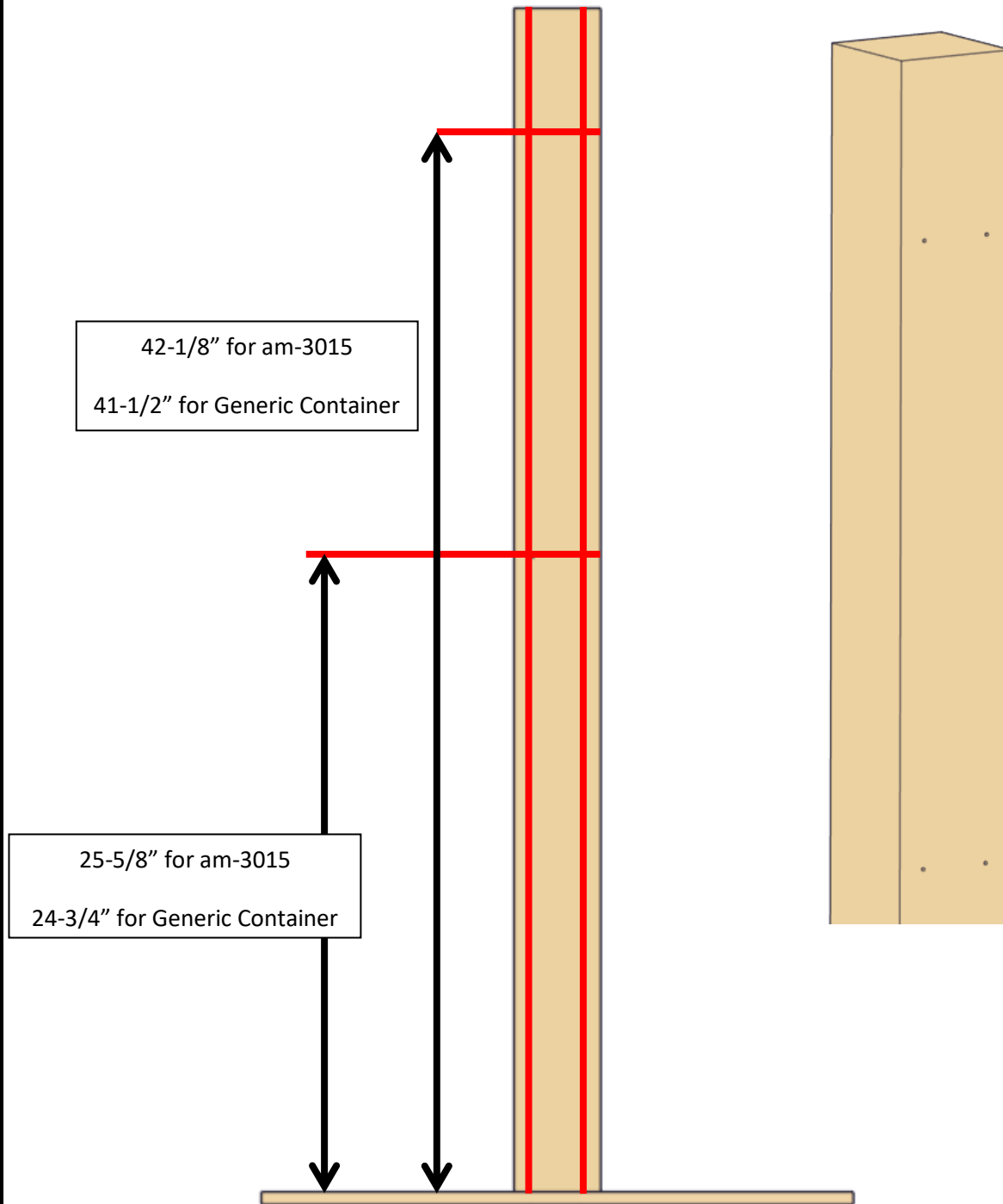

Step 6 (if using the Generic 2qt Containers)

On one side of each 2qt container, drill [2] holes $\sim 1/2"$ from the top of the container, $2"$ apart from each other, centered and level in the container. Then use [4] woodscrews to affix the containers to the 4x4. Check to ensure sure the leading edges of the containers are at $25.25"$ and $42.5"$ from the base of the structure ($25.75"$ and $43"$ from the playing surface).

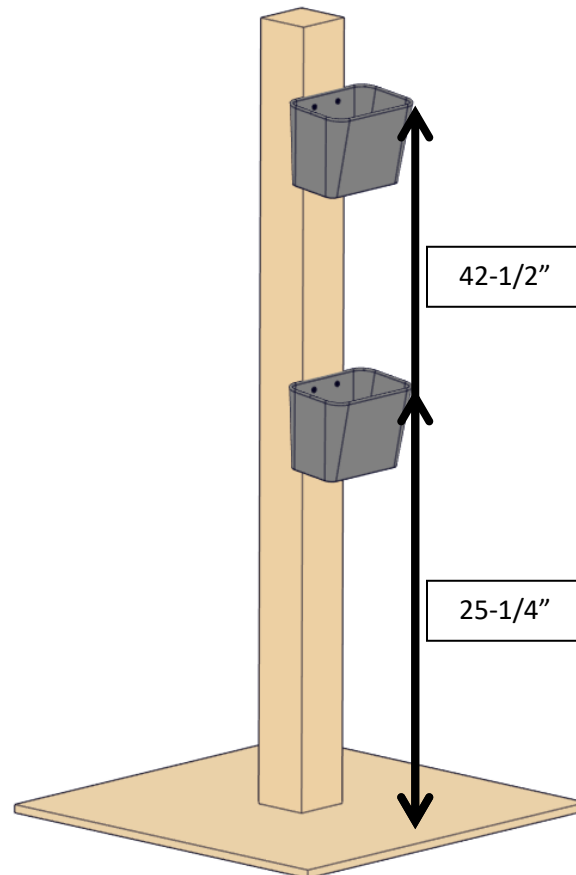
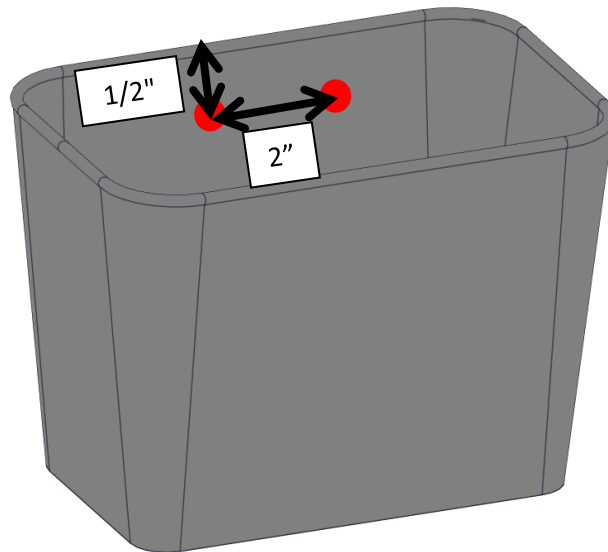

Step 6 (if using the AndyMark am-3015 Baskets)

Insert the [4] woodscrews through the Baskets at their topmost holes and use a drill to screw them to the 4x4. Check to ensure sure the leading edges of the containers are at 25.25" and 42.5" from the base of the structure (25.75" and 43" from the playing surface).

